

# USER'S INFORMATION MANUAL

(Supplementary)

Use and Care Instructions  
For Maintaining  
Heating and Cooling Performance

## Heat Pump Dual Fuel Control Kit

This user's information manual is to be used when the outdoor heat pump is used in conjunction with a fossil fuel furnace and the **3024-7481/F dual fuel control kit**. This manual intended to supplement the users manual you received from the outdoor heat pump. Please refer to the heat pump manual for information on "How Your Heat Pump Works", "System Operation", the "Heating Cycle" and how "To Maximize Efficiency".

### How Your Dual Fuel Control Works

Your dual fuel control is designed to separately operate both the heating systems of the heat pump and the furnace. The only time that both will operate simultaneously is during the defrosting of the heat pump where the furnace is operated to temper the discharge air from your air registers.

Your dual fuel control is equipped with an outdoor air temperature sensor. The setting of the outdoor air temperature sensor has been adjusted by your installer to an economic balance point. At outdoor air temperatures above this setting, your heat pump will provide all the heat your home will

ever need. At the outdoor air temperature below this setting, the dual fuel control locks off the heat pump and turns on the furnace. As long as the outdoor air temperature remains below your sensor setting your furnace will provide all the heat your home will need.

Your installer has calculated the outdoor temperature range for operating your system comfortably and efficiently and adjusted the sensor to provide the most comfortable and economical heating system operation for your home.

Heat Pump operation can be bypassed by switching the wall thermostat's switch to "Emergency Heat". Then only the furnace will be used in heating the home. If the outdoor heat pump should ever fail or be switched off in the wintertime, the furnace will take over heating the home until the situation has been corrected.

### IMPORTANT

*At times, during "Normal" operation you may notice a sudden change in temperature of the air*

*being discharged from the warm air registers. This change in temperature is due to the heating system switching from heat pump operation to furnace operation.*

When the furnace is in operation, the discharge air will be warmer than the discharge air when the heat pump is in operation. This is a normal characteristic of a heat pump system when used with a fossil fuel furnace and does not indicate a service problem.

**NOTE:** If the furnace has not been "readied" for heating (ex. Gas turned on, pilot lit, pilot lit if ignition model, etc.) and a cold front moves into the area which needs the furnace operation to maintain the selected temperature, the thermostat will automatically turn off the heat pump and try to get the furnace to turn on. Since the furnace will not be able to turn on, the home will get very cold. Be sure the furnace is ready to produce heat whenever needed.

# INSTALLATION INSTRUCTIONS

## 3024-7481/F HEAT PUMP DUAL FUEL CONTROL KIT

Supersedes: Nothing

035-15767-401B

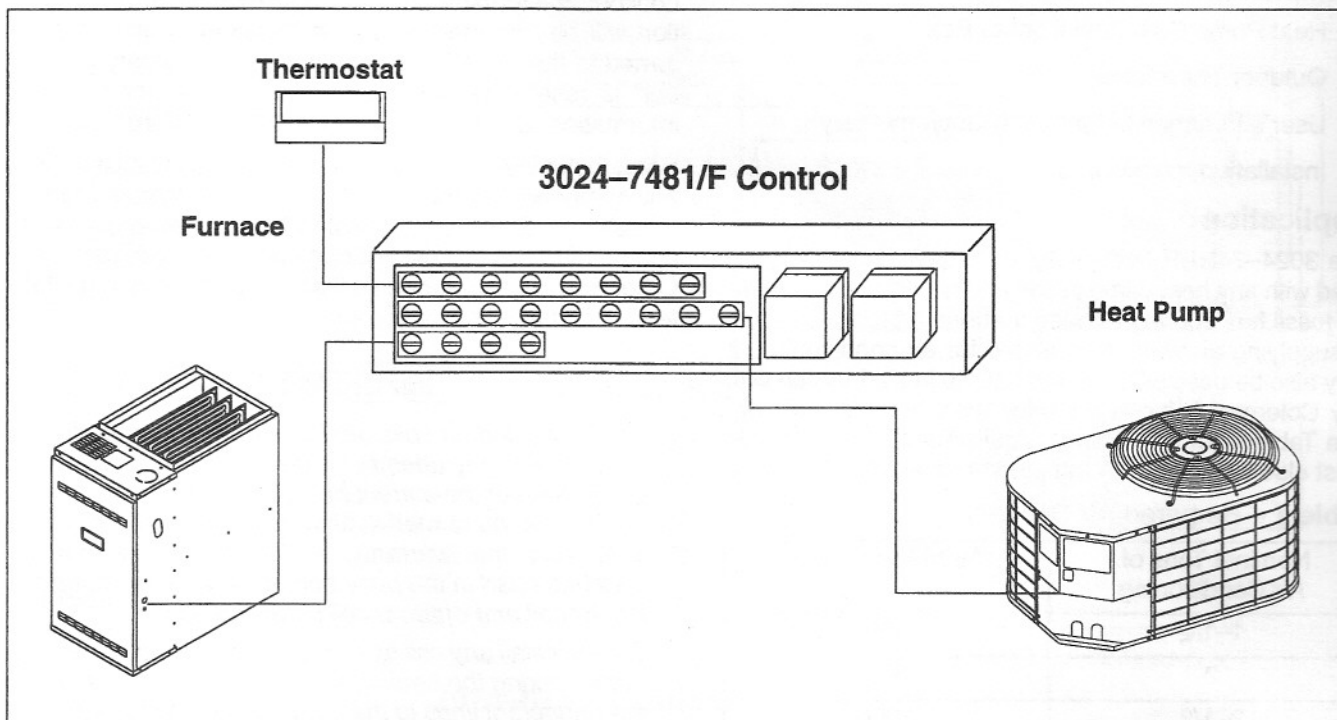

## SAFETY RULES

### IMPORTANT

*These instructions are intended for the use of qualified individuals specially trained and experienced in installation of this type of equipment and related system components.*

*Installation and service personnel are required by some states to be licensed.*

*Persons not qualified shall not install this equipment or interpret these instructions.*

### WARNING

*Improper installation may damage equipment, can create a shock hazard, and will void the warranty.*

## Comply with Local Codes

The installer should comply with all local codes and regulations which govern the installation of this type of equipment. Local codes take precedent over any recommendations contained in these instructions. In lieu of local codes, the equipment should be installed in accordance with National Electric Code and in accordance with the recommendations made by the National Board of Fire Underwriters.

### CAUTION

**FIRE HAZARD** – Failure to observe the following warnings could cause furnace malfunction resulting in fire or asphyxiation.

1. When indoor heat pump coils are used with fuel burning furnaces, they must be installed in the discharged air stream. Installation of a heat pump coil in the return air stream of a fuel burning furnace could cause excessive heat exchanger corrosion and burner malfunction.
2. No attempt shall be made to operate the heat pump in the heating mode at the same time the fuel burning furnace is in operation. Failure to observe this warning will result in abnormally high refrigerant temperatures and pressures resulting in system failure.

Ground unit to prevent electric shock.

Before making electrical connections or servicing the system, disconnect power to both the indoor and the outdoor units.

**NOTE:** The words “Shall” or “Must” indicate a requirement which is essential to satisfactory and safe product performance.

The words “Should” or “May” indicate a recommendation or advice which is not essential and not required but which may be useful or helpful.

## General Information

### Contents of this Package are:

1. Heat Pump Dual Fuel Control Box
2. Outdoor Thermostat
3. User's Information Manual (Supplementary)
4. Installation Instructions

## Application

The 3024-7481/F heat pump dual fuel control may be used with any heat pump in conjunction with any residential fossil fuel burning furnace that has a blower capable of supplying air volumes suitable for air conditioning. It may also be used with any heat pump in conjunction with any Coleman / Evcon manufactured housing furnace. See Table 1 for air volume requirements. The furnace must also have a 40 VA transformer and a blower relay.

**Table 1 – Required Air Delivery**

Nominal Tons of Air Conditioning	Air Volume CFM
1-1/2	600
2	800
2-1/2	1000
3	1200
3-1/2	1400
4	1600
5	1800

The control is designed to separately operate the heating systems of the heat pump and the furnace. The only time that both will operate simultaneously is during the defrosting of the heat pump where the furnace is operated to temper the supply air to the conditioned space.

During normal heating operation the wall thermostat controls the temperature of the home. The outdoor thermostat is used to select either the heat pump or the furnace, depending on its set-point. At outdoor ambient temperature above the set-point, the heat pump will operate to maintain the home comfort. Below the set-point, the furnace operates. Regardless of which system is operating, the first stage of the wall thermostat is normally in control (unless the home loses heat faster than can be compensated for by the heat pump, at which point the second stage of the wall thermostat will turn on the gas furnace until the first stage is satisfied).

If the wall thermostat selection switch is placed in "Emergency Heat" position, or during a heat pump "Safety Lockout" the furnace will provide all heat. Normal operation will be resumed when the "System" switch is returned to the "Heat" position, or when the Safety Lockout" is reset (see heat pump instructions for further information about a "Safety Lockout" condition).

Read these instruction carefully before the installation of any component of the heat pump system. Where these instructions differ from the instruction packed with other components, these instructions shall take precedence. Otherwise, use components that do not differ as a guide line for installing those components.

### IMPORTANT

*Heat pump indoor coils are different from air conditioning coils. Any attempt to use an air conditioning coil instead of the correct heat pump coil will cause the heat pump to malfunction, damage the system and, void the warranty. Refer to the system matchup chart in the price book for the appropriate indoor coil and outdoor coil combinations.*

*Do not install any coil to a furnace which is to be operated during the heating season without attaching the refrigerant lines to the coil and opening the system service valves. Failure to do so will cause excessive pressures within the coil that could damage the coil and cause personal injury.*

*In most cases, the control package should not be retrofitted to gun furnaces; use a 3024C7473 control package for these applications. The 3024C7473 control includes a 40 VA transformer, blower motor terminals, and a blower control relay that are required for such applications.*

### NOTE:

1. The heat pump outdoor unit, indoor coil, and refrigerant line set must be matched up as shown in the tabular data sheet packed with the heat pump outdoor unit.
2. For horizontal coil applications, field fabricated blank-off plates or transition plenum may be required to fit the coil cabinet to the furnace outlet flanges.
3. Amp. draw for the wall thermostat's first stage heat anticipator is a non-adjustable .6 amp. The second stage anticipator should be adjusted to .3 amp.

### 3024-7481/F Heat Pump Dual Fuel Control Kit

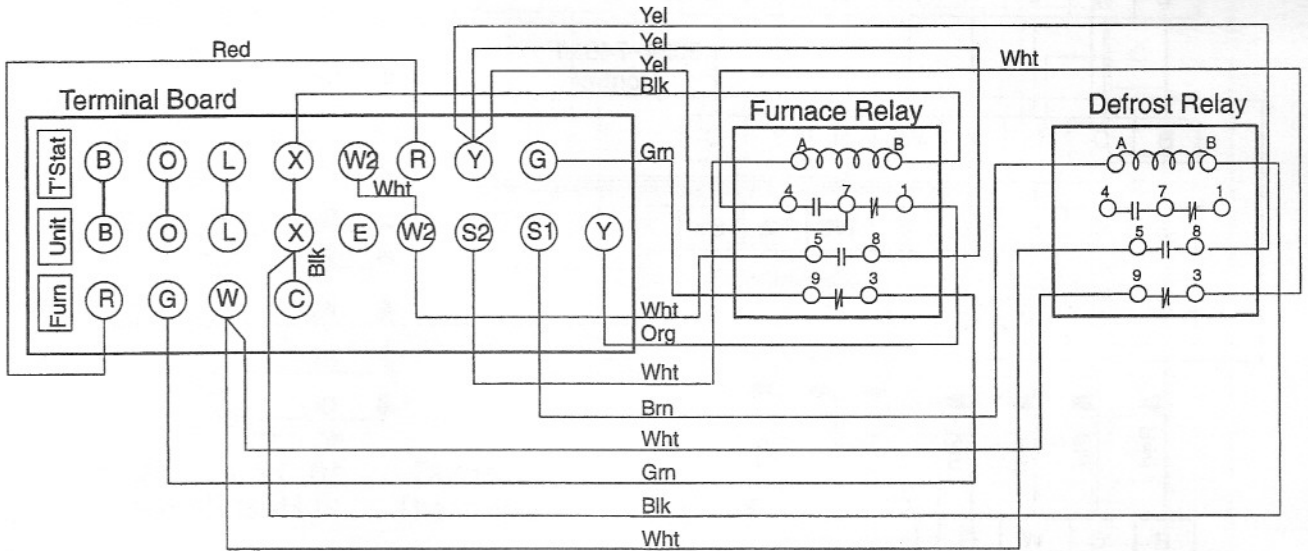

Figure 1

### 3024-671/F Outdoor Thermostat

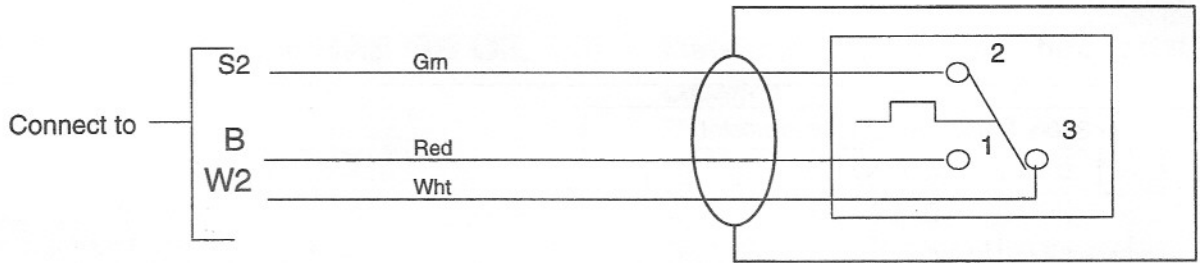

Figure 2

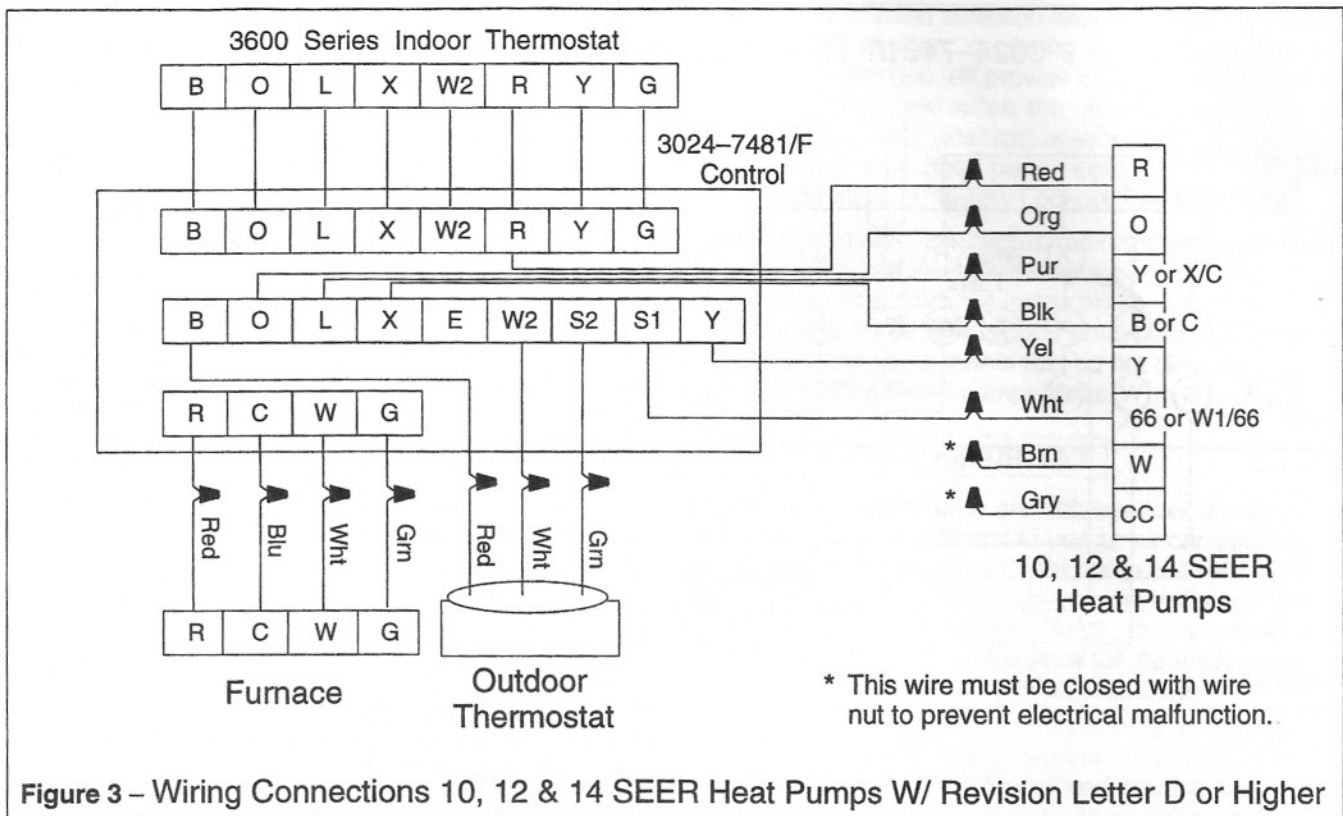

Figure 3 – Wiring Connections 10, 12 & 14 SEER Heat Pumps W/ Revision Letter D or Higher

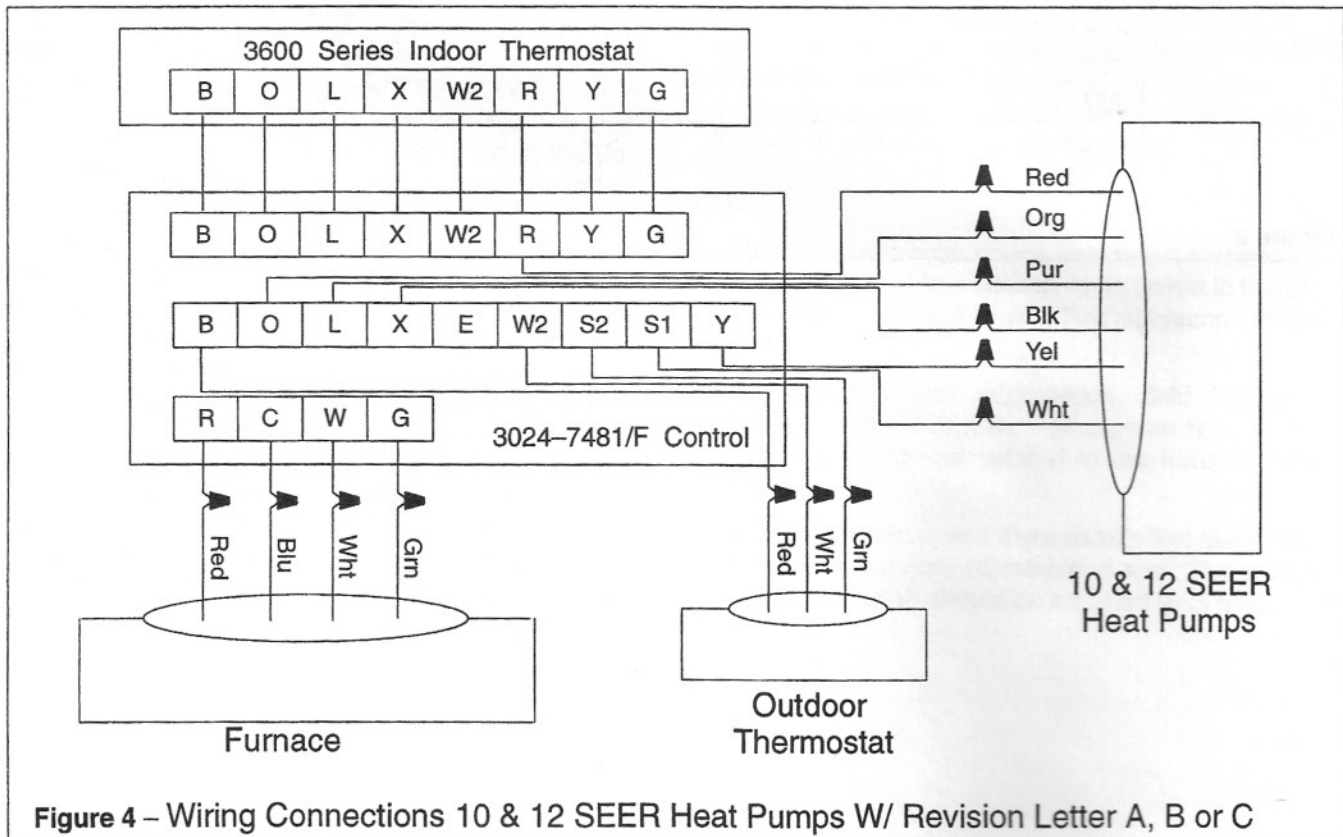

Figure 4 – Wiring Connections 10 & 12 SEER Heat Pumps W/ Revision Letter A, B or C

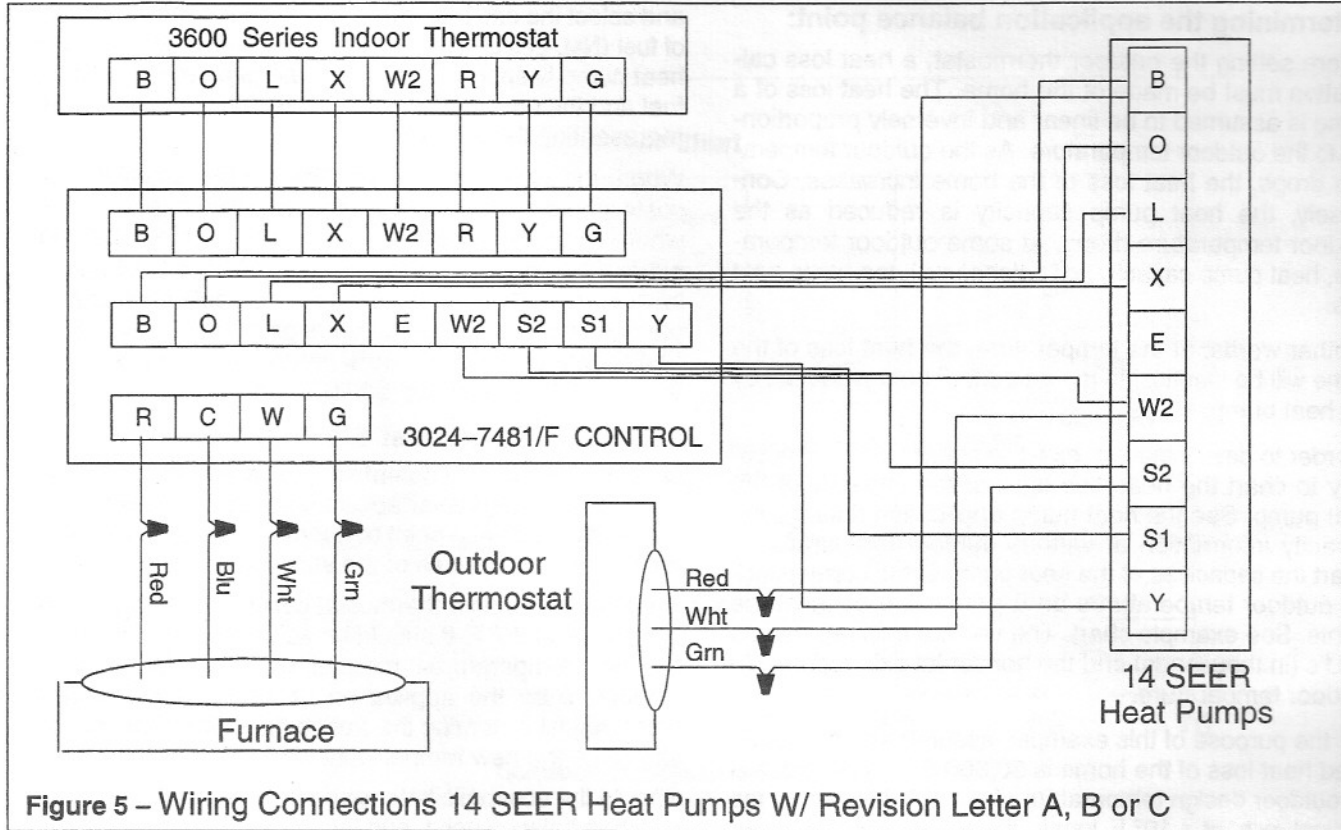

Figure 5 – Wiring Connections 14 SEER Heat Pumps W/ Revision Letter A, B or C

## INSTALLATION ON GAS OR OIL FURNACE

### **⚠ WARNING**

**SHOCK HAZARD** – Disconnect electric power to equipment before installation to prevent equipment damage and possible personal injury.

The furnace must have a blower capable of delivering the air volume specified in Table 1 and be air conditioning ready.

Install heat pump coil and cabinet onto the outlet of the furnace. See instruction packed with these components. Route the refrigerant lines from the outdoor heat pump unit to the indoor heat pump coil per the instructions packed with the heat pump.

Mount the 3024-7481/F control box on the outside of the furnace casing or on a wall near the furnace. The control box may be located outside directly on certain outside gas furnaces. The location and installation must conform to approved electrical codes. If the furnace does not have a 40 VA (or larger) transformer, and an A/C blower relay, those items must be installed at this time.

Low voltage control wiring to the furnace, wall thermostat, outdoor heat pump unit, and 3024-7481/F control box should be connected per Figures 3, 4, or 5. Use Figure 3 for heat pump with revision level "D" or higher. Otherwise use Figures 4 or 5 as applicable.

## Installation of Outdoor Thermostat

### Location

The outdoor thermostat is designed to be installed in an outdoor environment. However, constant shade is the determining factor in selecting a location for the outdoor thermostat. Radiant heat from direct rays of the sun could affect the operation of the thermostat.

There may be some heat pump models that provide an attachment location for the outdoor thermostat, most models do not. Careful selection should be used in locating the outdoor thermostat. The electric cable provided is long enough to allow the thermostat to be mounted on a nearby structure.

### Wiring

Remove the cover from the heat pump control box. Route the end of the cable through the grommet and into the low voltage box. Connect cable to the correct terminations, see Figure 3, 4, and 5 for the particular models. Coil and neatly tie excess cable. Replace cover in unit control box and set outdoor thermostat.

## Setting the Outdoor Thermostat

### **IMPORTANT**

*The outdoor thermostat should not set lower than the application balance point temperature. It is permissible to set the outdoor thermostat above this temperature if it is economically beneficial.*

### Determining the application balance point:

Before setting the outdoor thermostat, a heat loss calculation must be made of the home. The heat loss of a home is assumed to be linear and inversely proportionate to the outdoor temperature. As the outdoor temperature drops, the heat loss of the home increases. Conversely, the heat pump capacity is reduced as the outdoor temperature drops. At some outdoor temperature, heat pump capacity will balance with the home heat loss.

In other words, at the temperature, the heat loss of the home will be identical to the amount of heat produced by the heat pump.

In order to determine the exact temperature, it is necessary to chart the heat loss against the capacity of the heat pump. See the heat pump application data for the capacity information at various outdoor temperatures. Chart the capacities of the heat pump at the corresponding outdoor temperatures on a graph and connect the points. See example chart. The vertical axis represents BTU's (in thousands) and the horizontal axis represents outdoor temperature.

For the purpose of this example, assume that the calculated heat loss of the home is 50,800 BTU's per hour at an outdoor design temperature of + 10° F. Moving up the vertical axis, at + 10° F, locate the number of BTU's per hour heat loss and mark that point on the graph. Placing a straight edge on this point, and aligning with the 70° F, (the normal indoor comfort condition) in the lower right-hand corner, connect these two points with a straight line. Locate the point at which the heat loss crosses the capacity curve of the heat pump. This intersection is the balance point temperature for the example application.

### Determining the economical balance point:

Turn to the economic balance point temperature charts

and select the one that represents the efficiency and type of fuel (Nat. gas LP gas, or Oil) of the furnace to which the heat pump is applied. Determine the price of the furnace fuel and the cost of electricity per KW, locate the curves representing those costs.

Where the two curves representing the fuel and electrical costs intersect is the economical balance point. It is where \$1.00 will purchase the same amount of BTU's from either the heat pump or the furnace. Mark the economic balance point for later reference. The application example shows an economic balance point of 25° F for a 12 SEER heat pump and a 80% natural gas furnace using \$0.08/KW electricity and \$0.60/Therm. gas.

### Adjusting Thermostat Set Point

On the chart that you determined the application balance point for your particular application, mark and label the economical balance point temperature on the curve representing the heat loss of the structure.

Remove the outdoor thermostat cover. The thermostat is factory set at 30° F. It should be adjusted to the higher of the two temperatures marked on "heat loss" curve whether it be the application or economical balance point. Adjust by turning the slot on the thermostat shaft to align with the new temperature setting.

Should the economic balance point be lower than the application balance point, and the outdoor thermostat is set to this temperature, the control will operate the heat pump until the home temperature drops to close the second stage of the wall thermostat, at which time the heat pump will be turned off and the furnace will operate. Under this condition, the furnace will continue to operate until the home temperature rises to satisfy the first stage. When the first stage of the wall thermostat closes again, the control will operate the heat pump and the cycle will repeat to maintain the home comfort. Replace the outdoor thermostat cover.

# Balance Point Charts

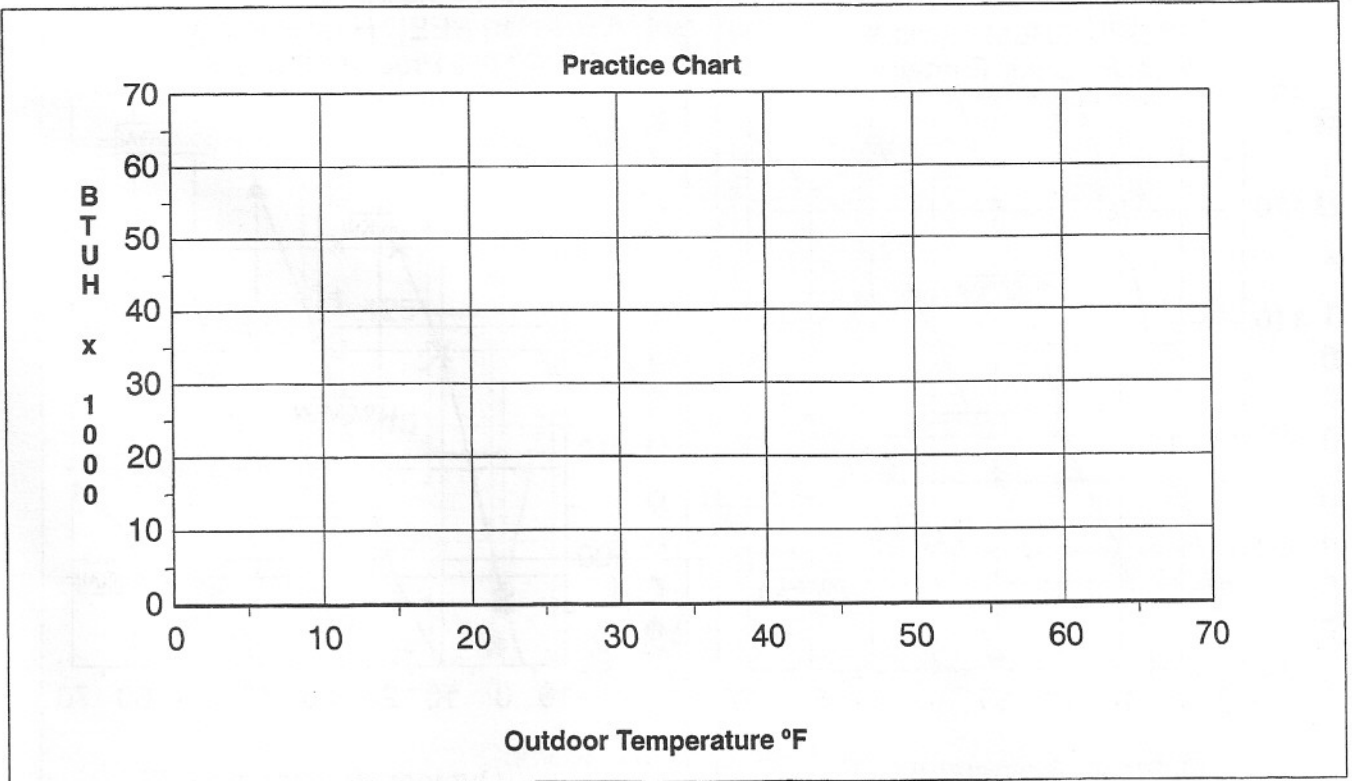
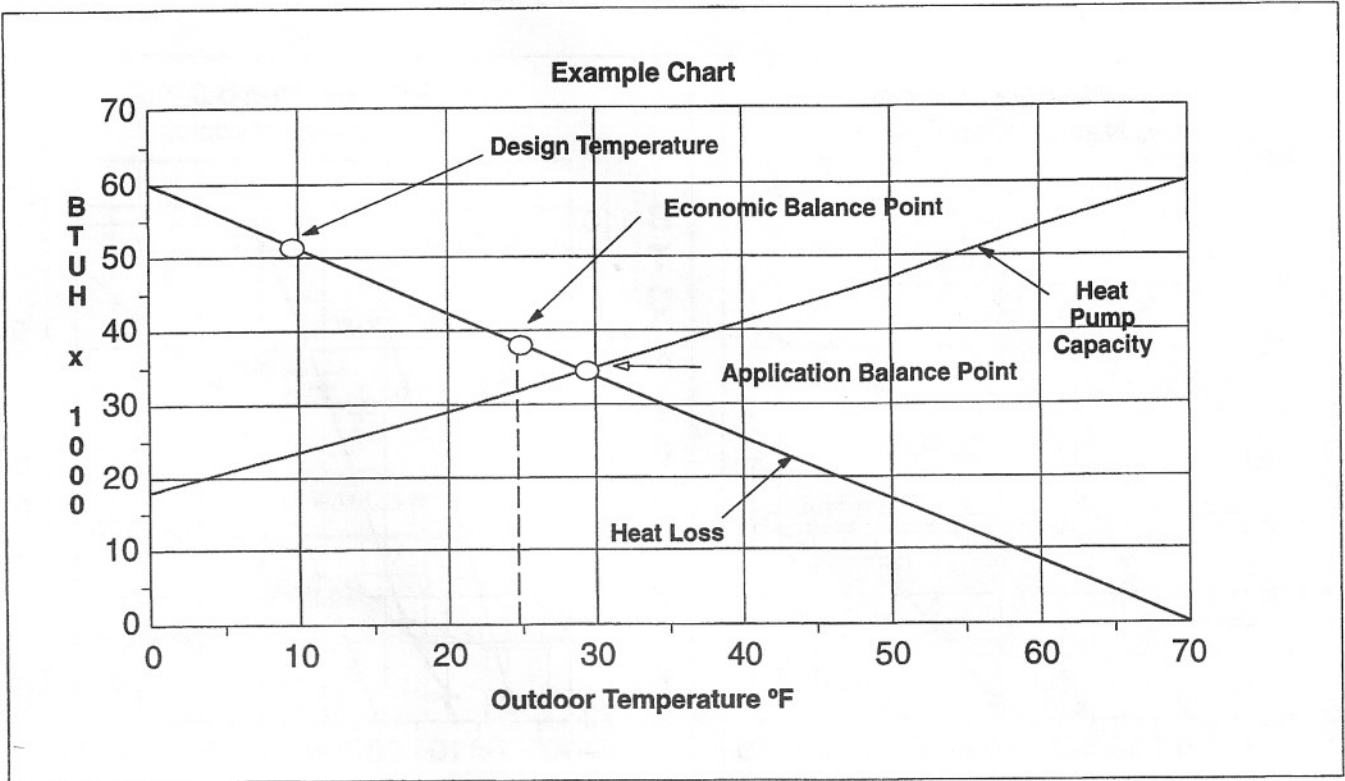



## Economic Balance Point Charts

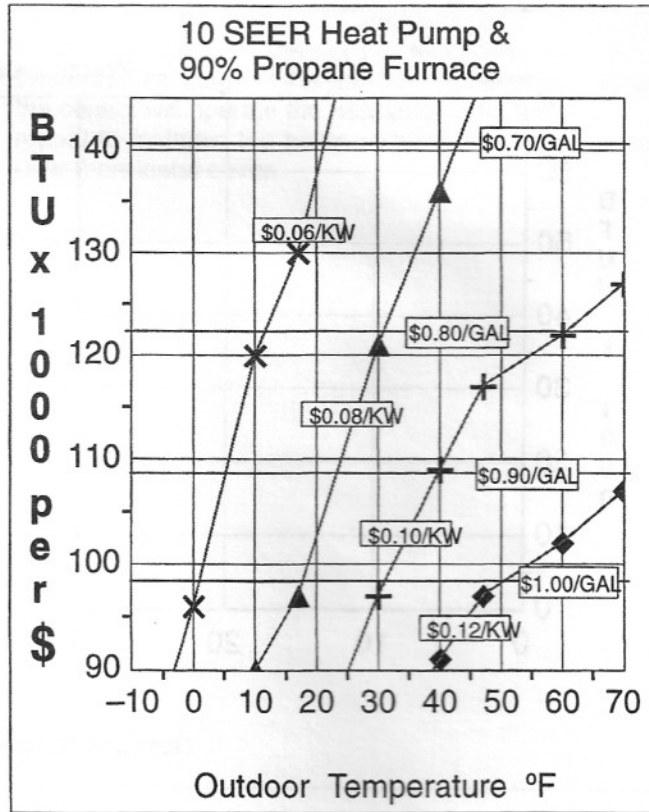
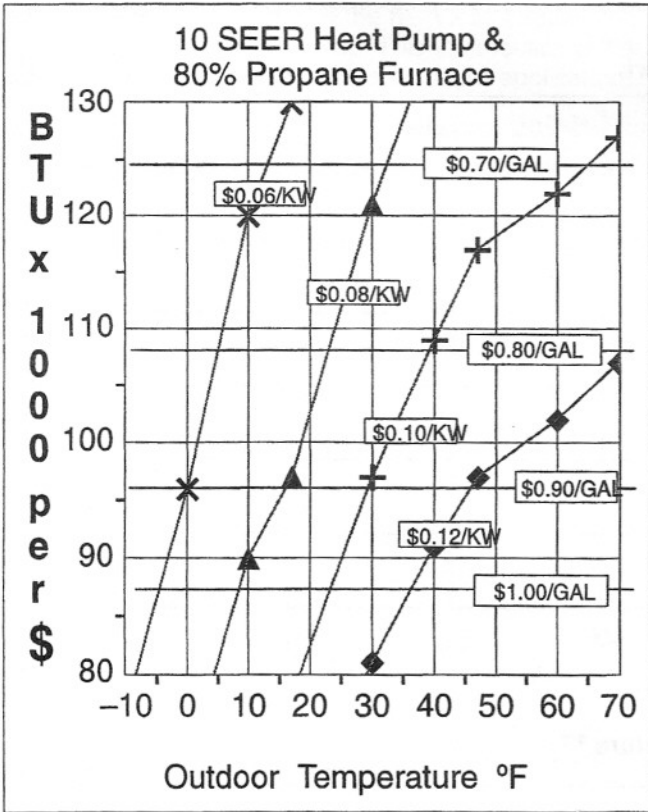
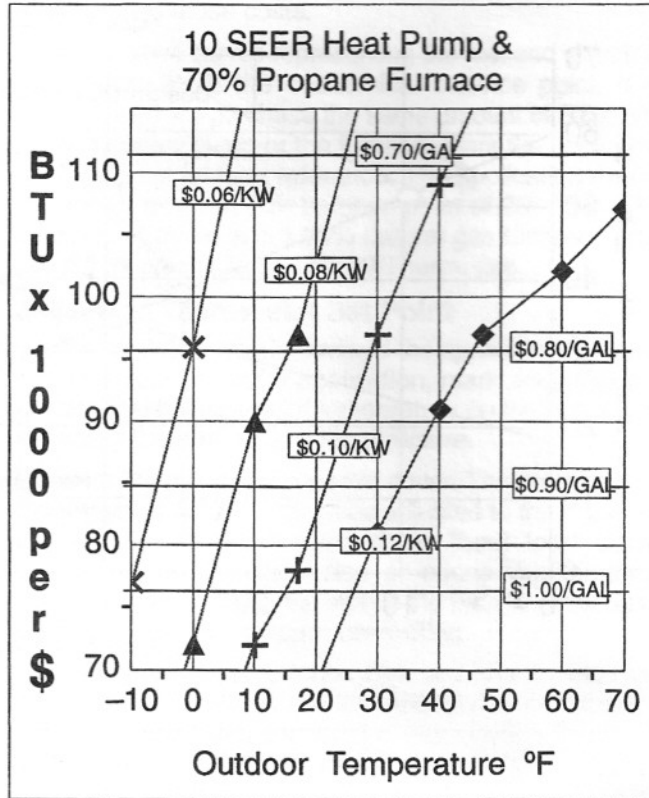
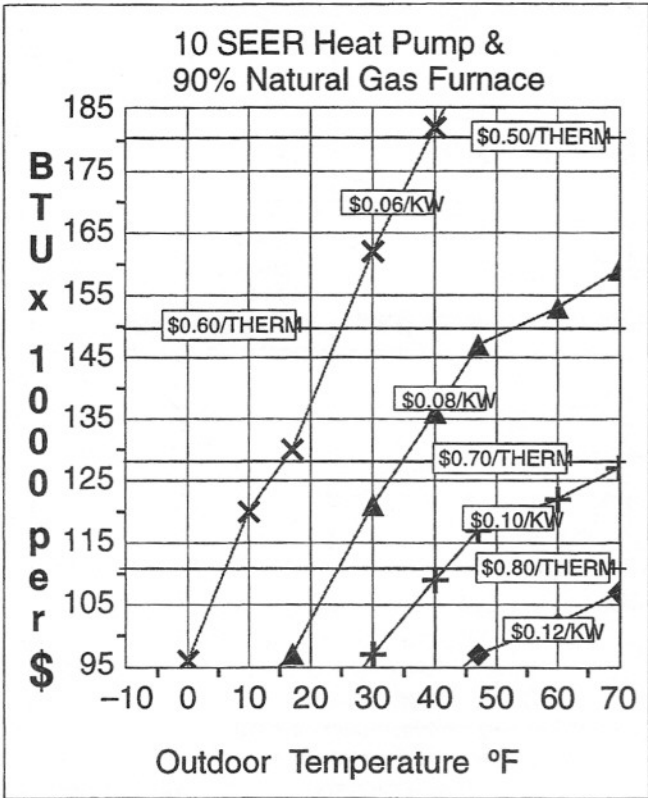

## Economic Balance Point Charts

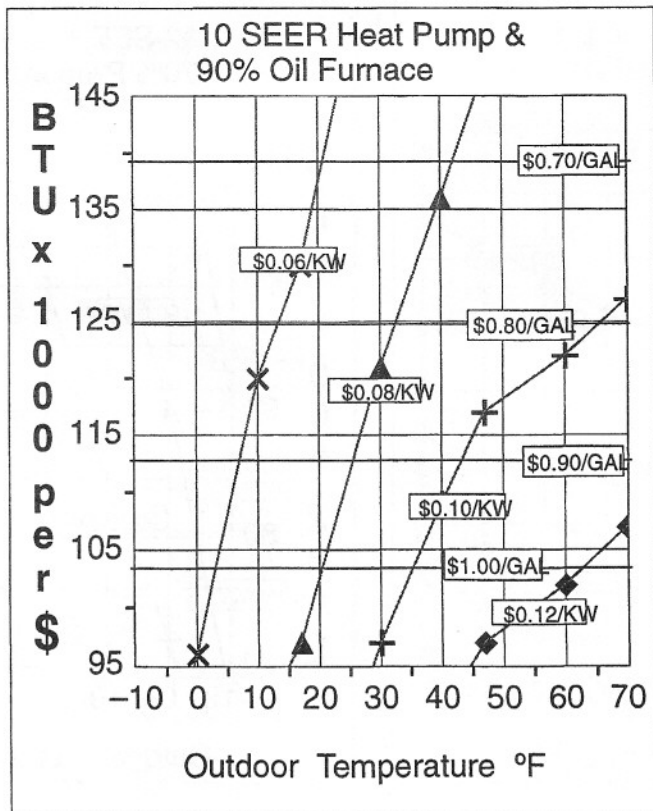
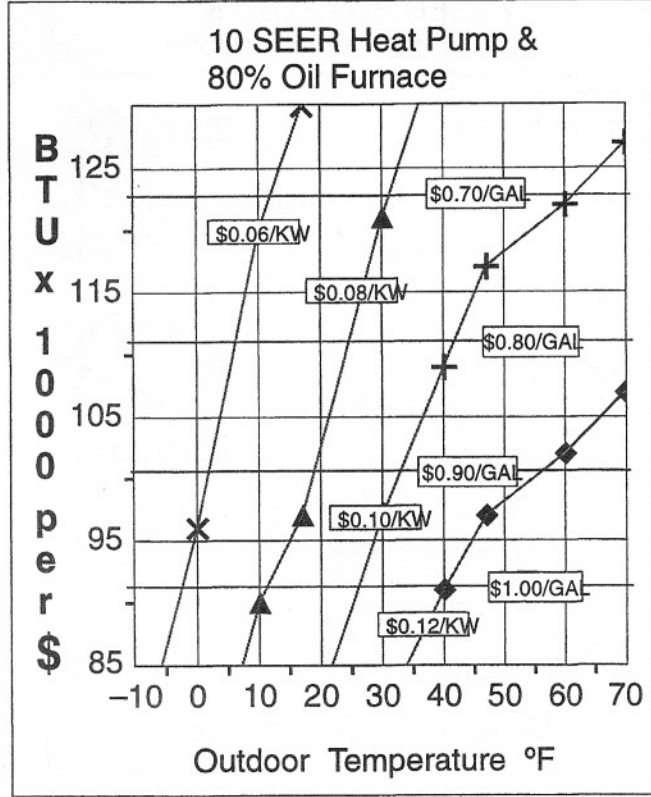
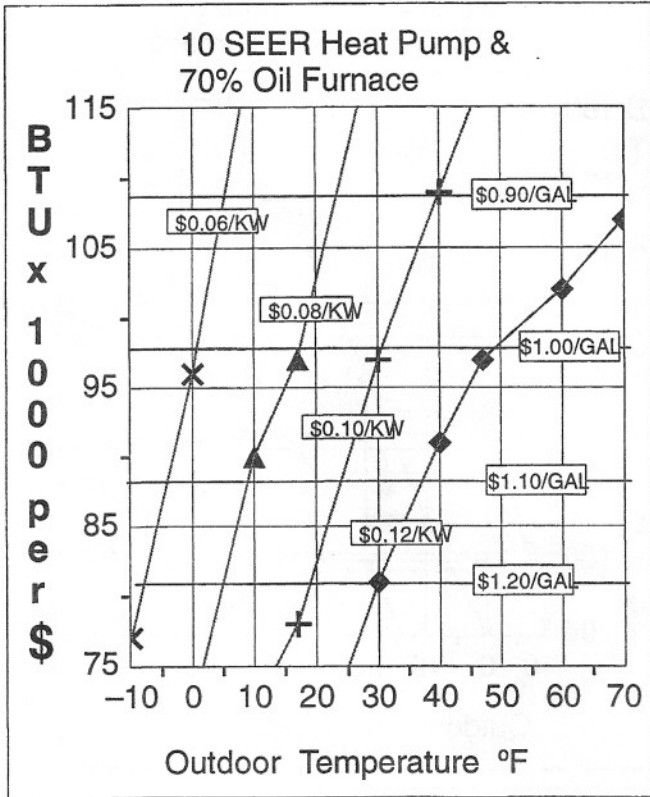

# Economic Balance Point Charts

12 SEER Heat Pump & 70% Natural Gas Furnace

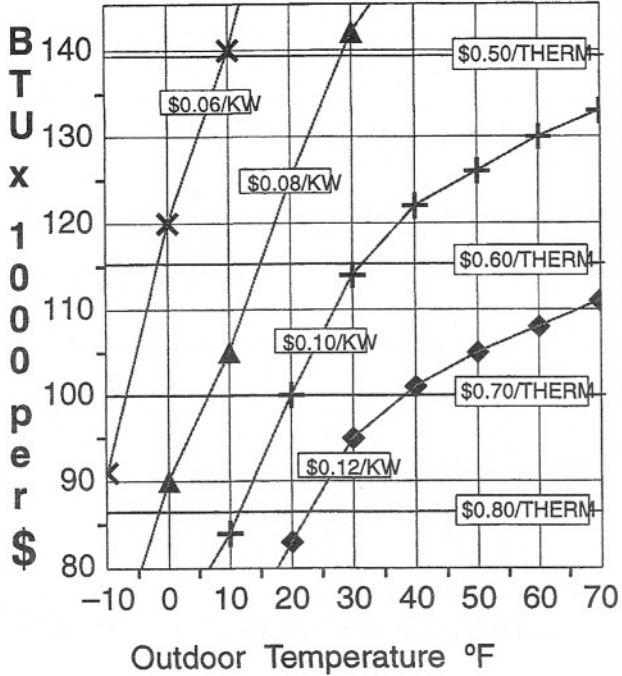

12 SEER Heat Pump & 80% Natural Gas Furnace

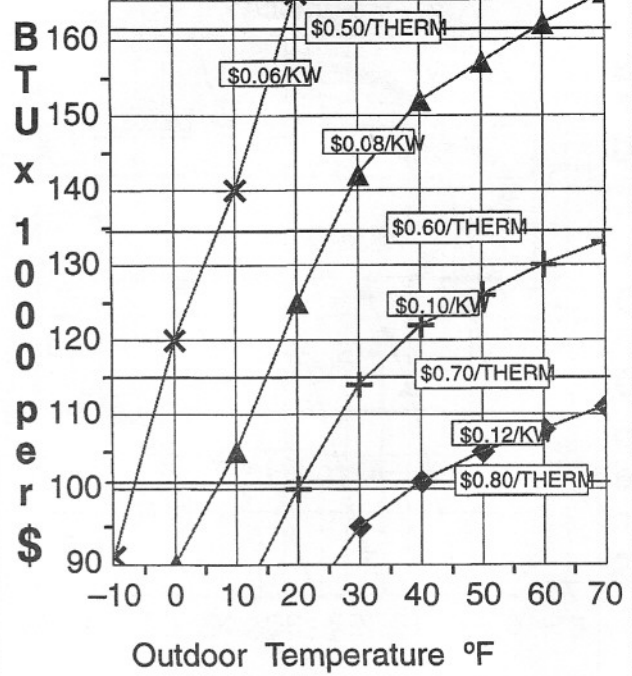

12 SEER Heat Pump & 90% Natural Gas Furnace

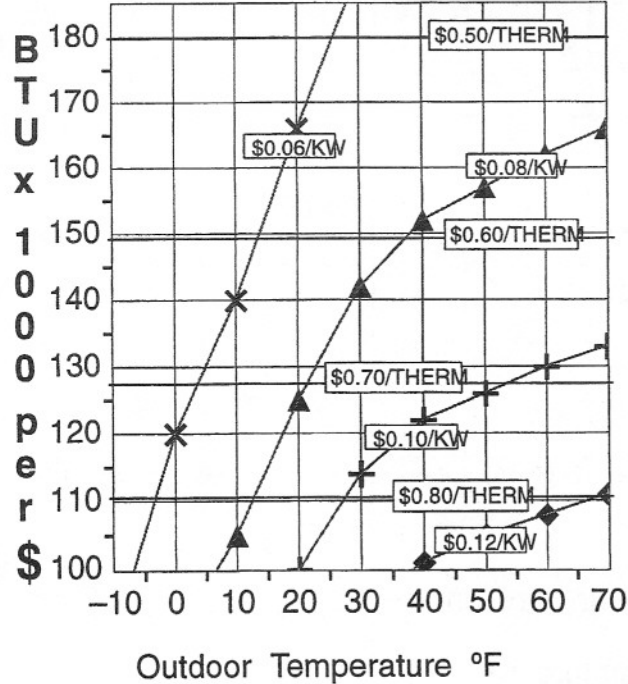

12 SEER Heat Pump & 70% Propane Gas Furnace

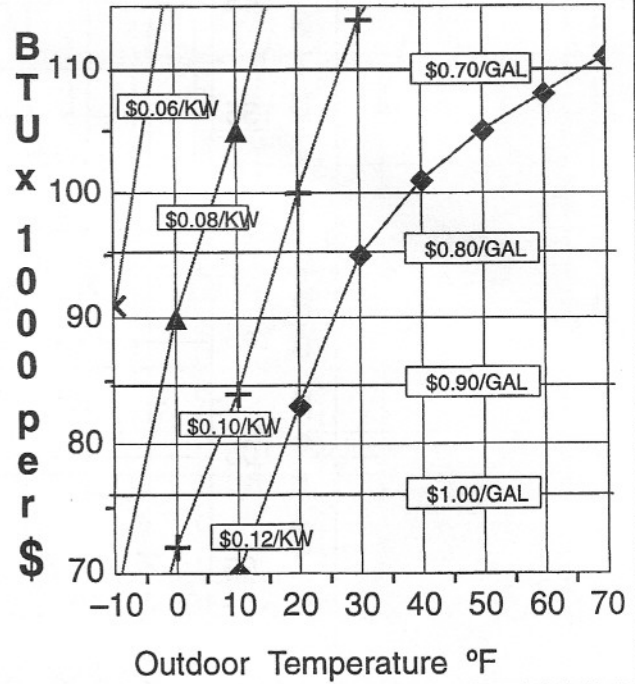

## Economic Balance Point Charts

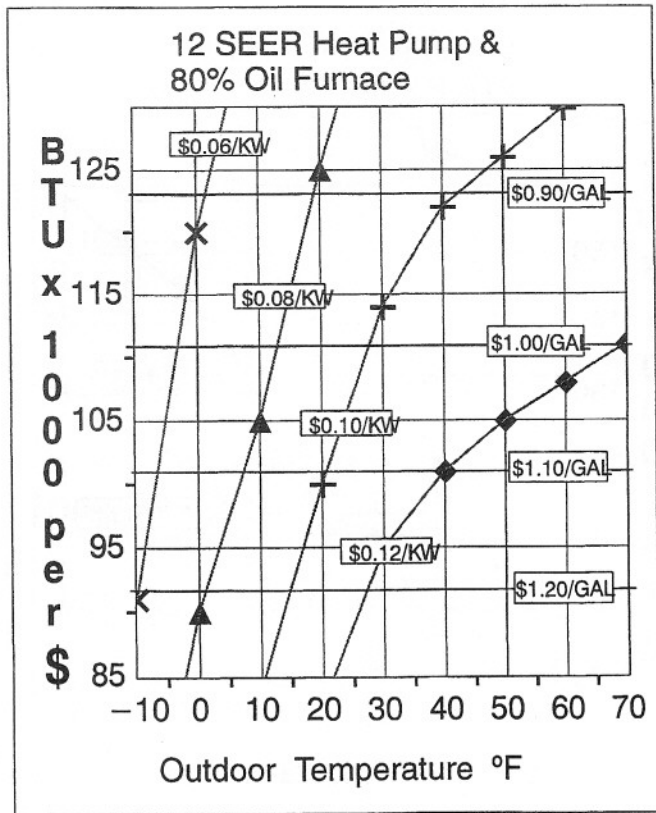
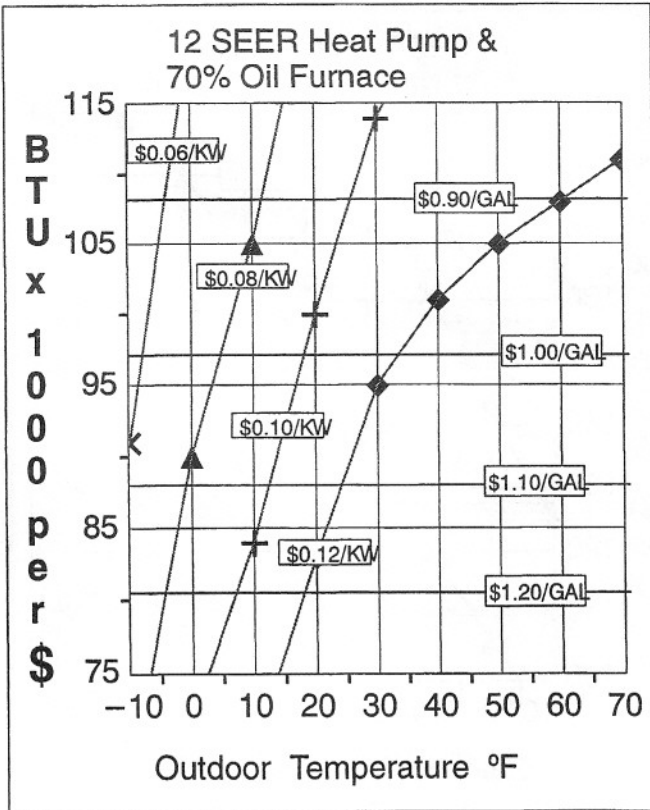
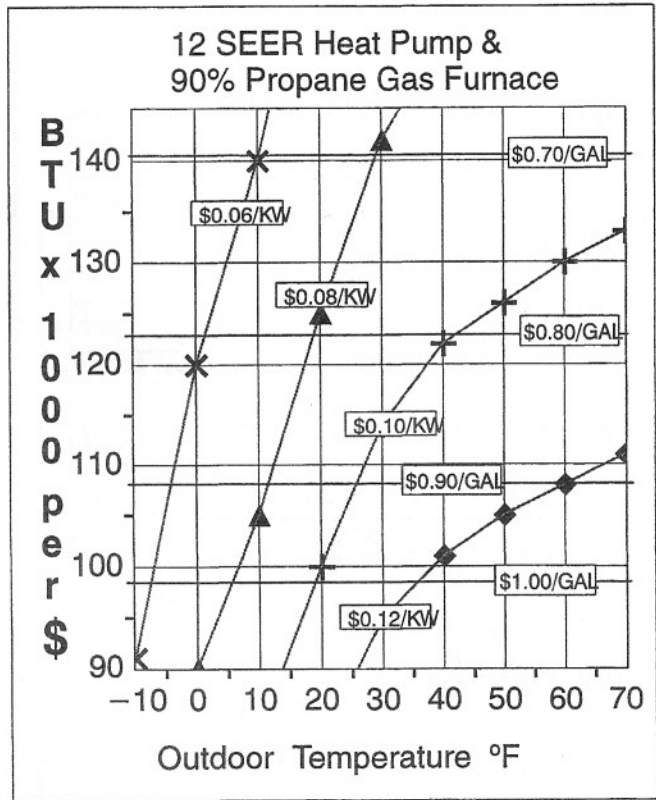
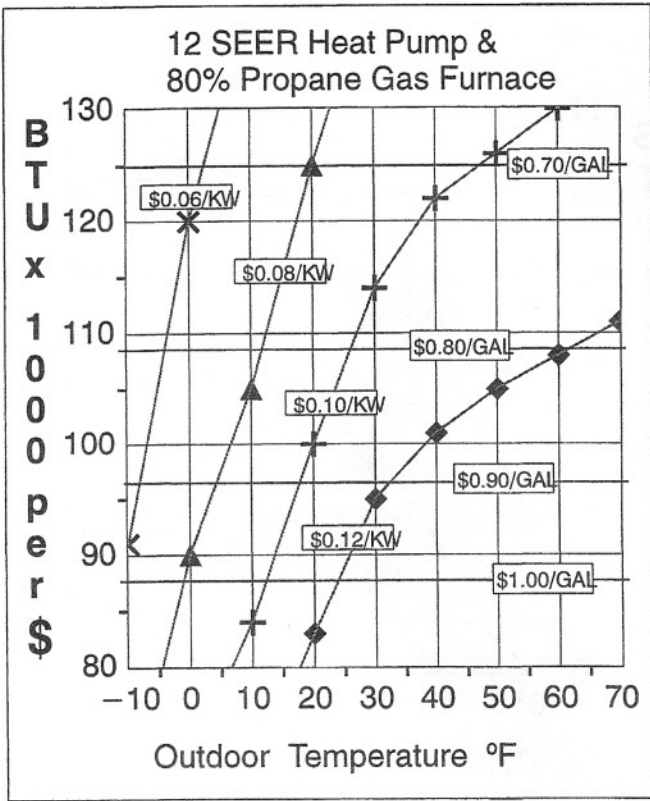

## Economic Balance Point Charts

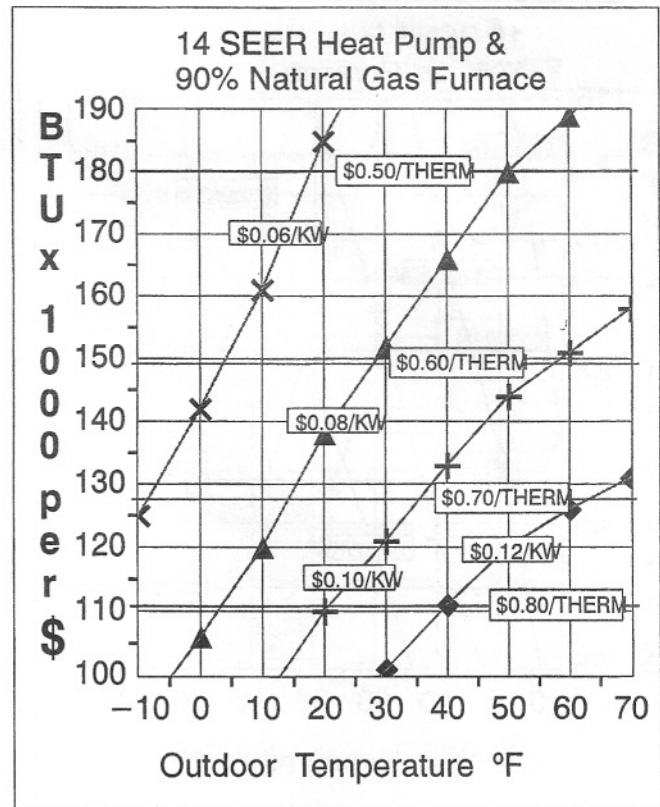
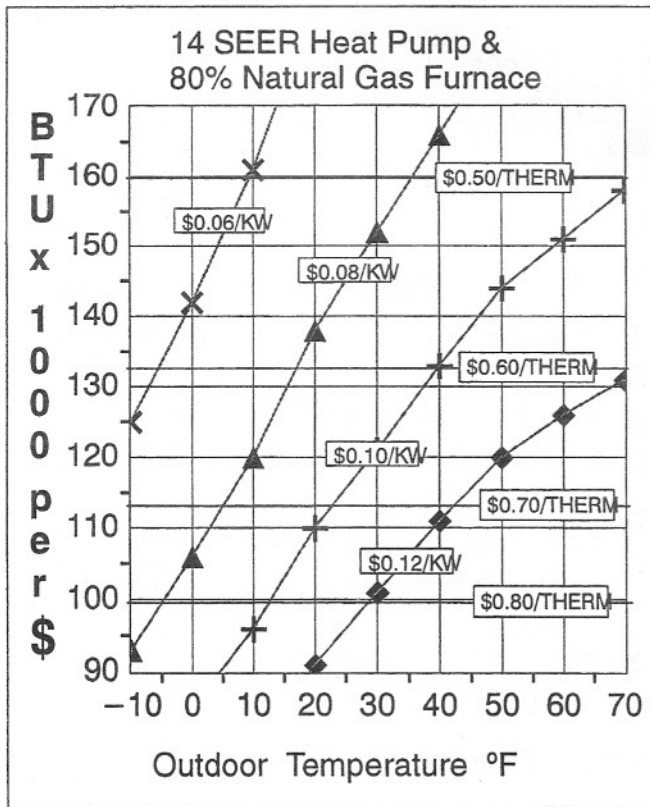
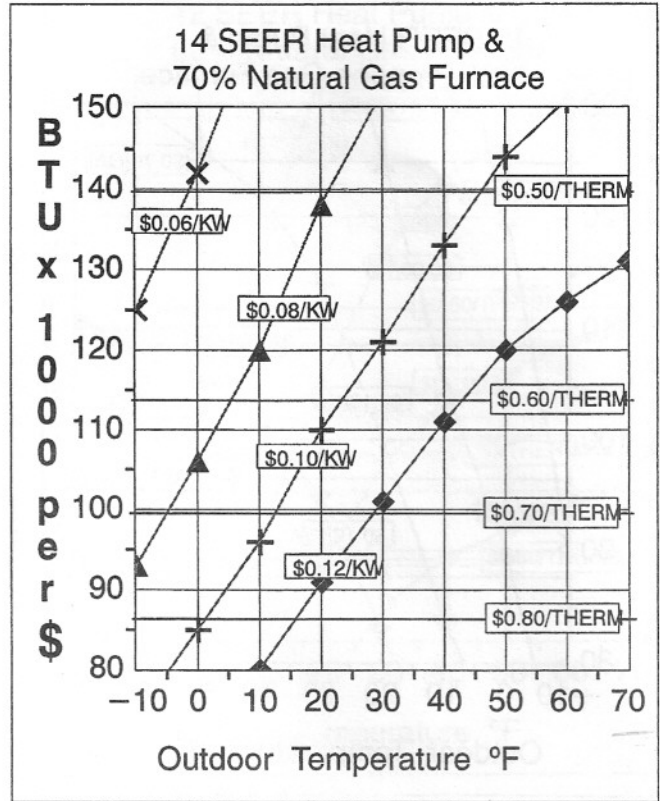
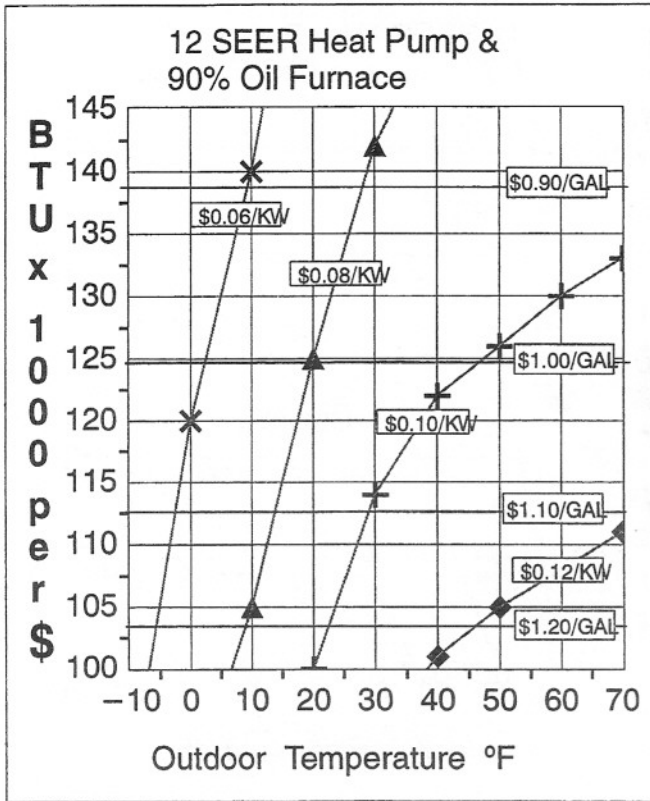

# Economic Balance Point Charts

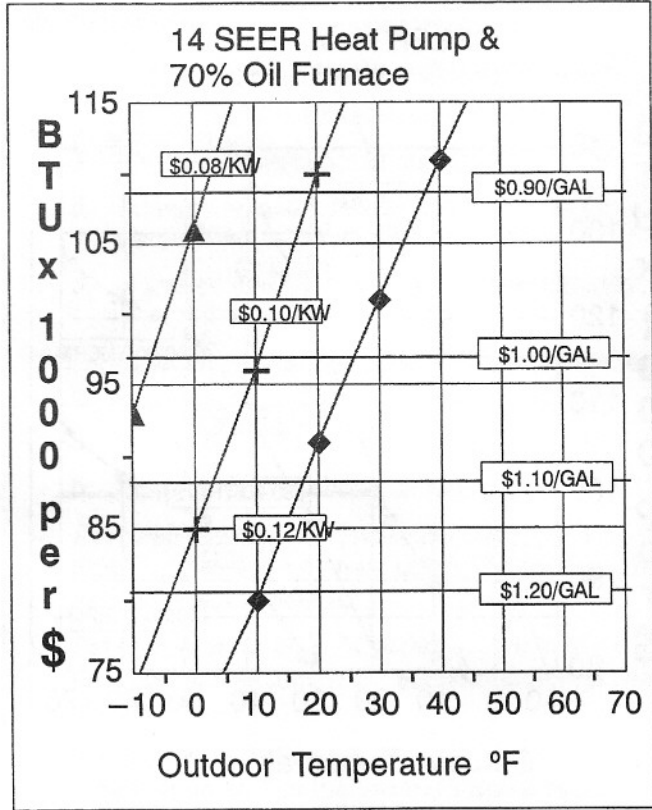
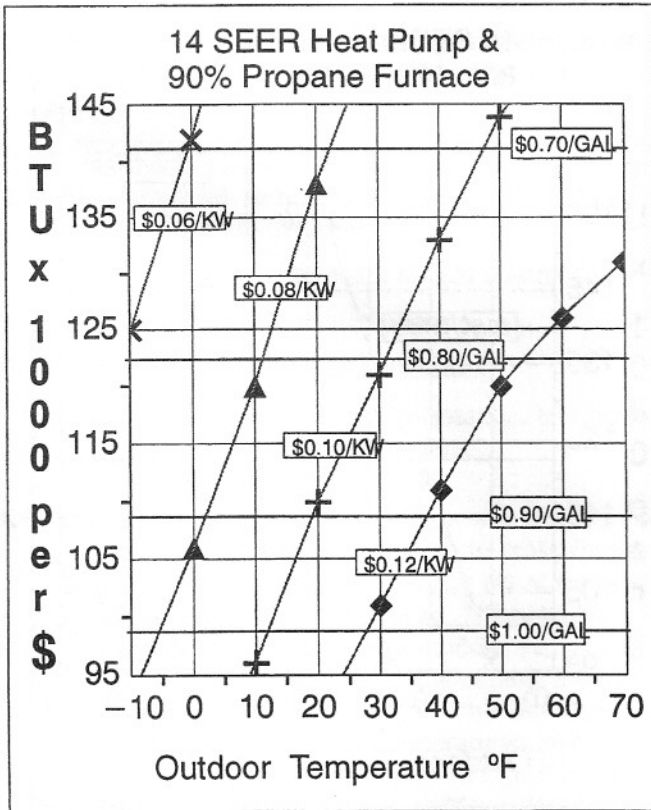
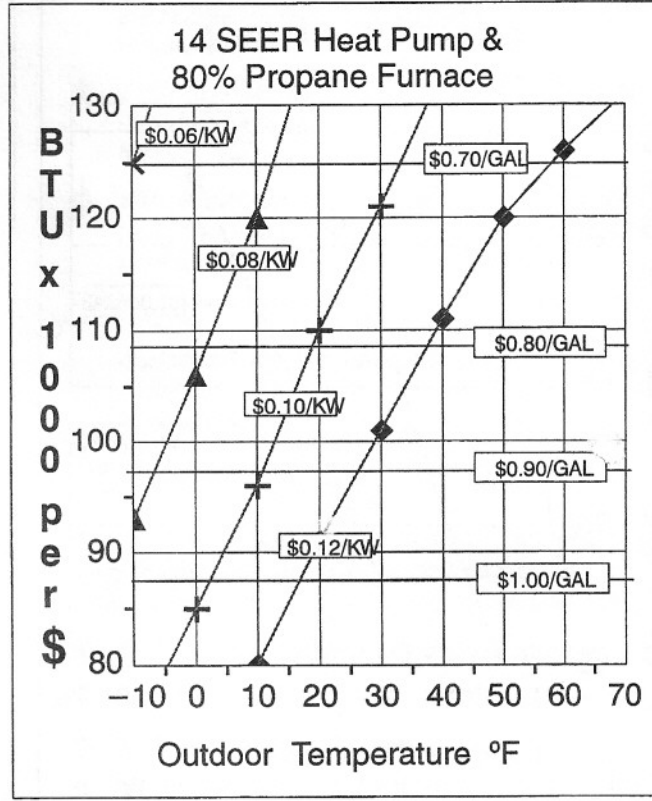
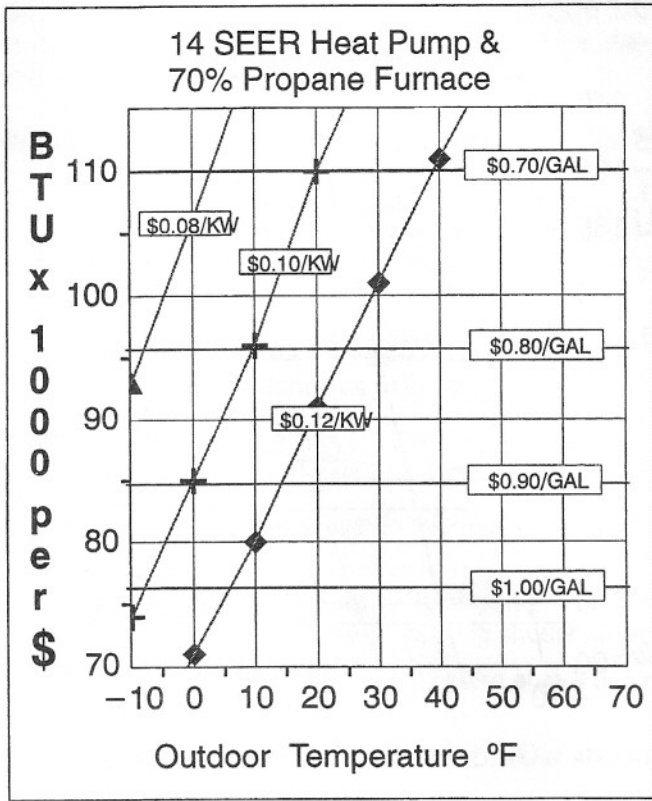

## Economic Balance Point Charts

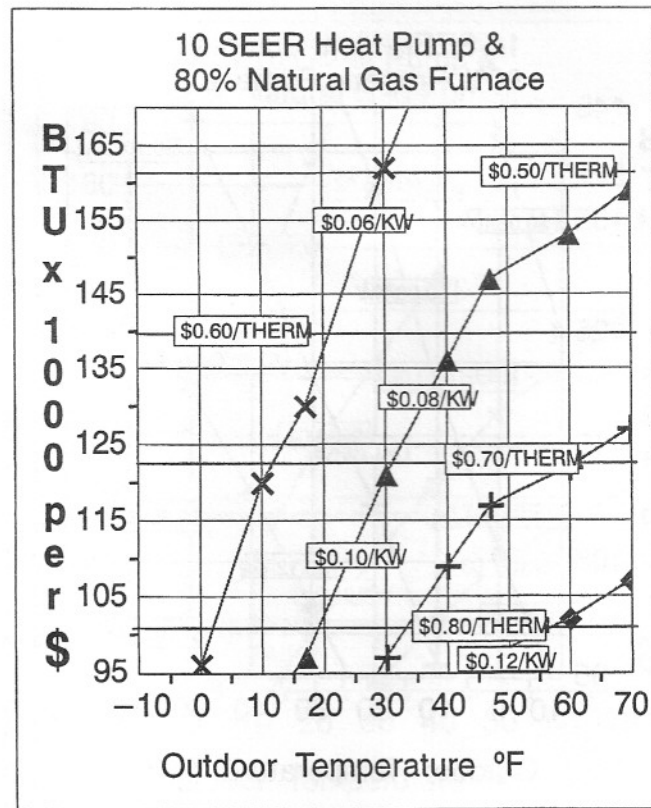
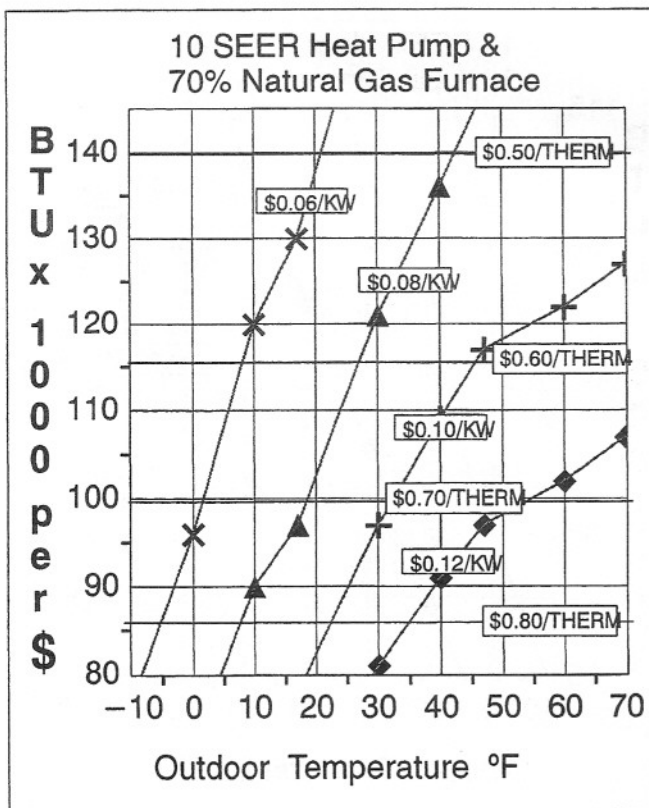
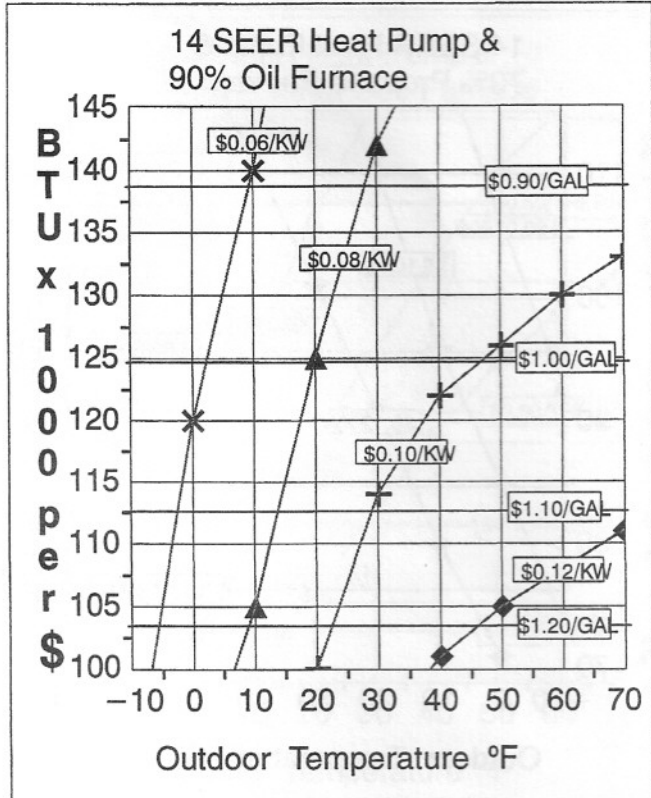
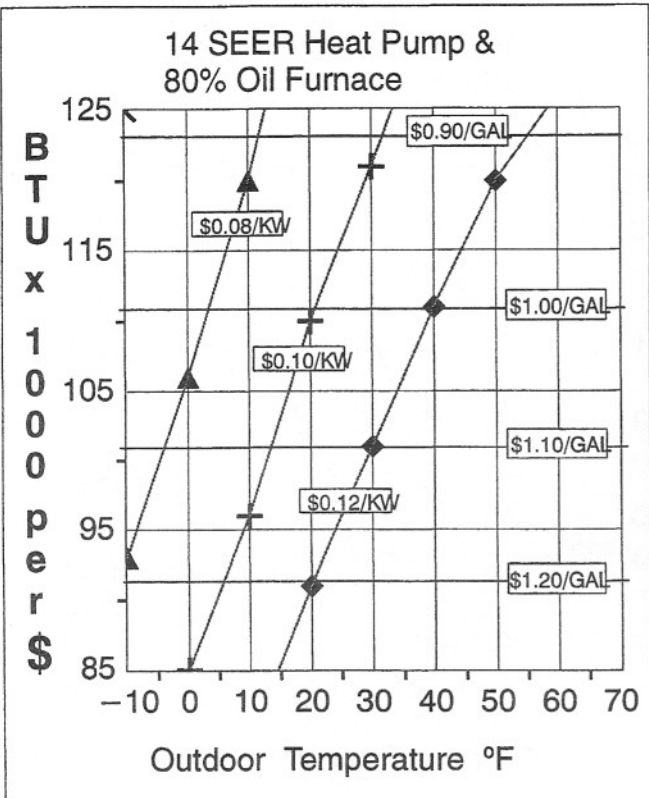

## SYSTEM OPERATIONAL CHECK-OUT

Go through the following steps to see if the system has been wired correctly and will respond to the wall thermostat commands.

**NOTE:** If a 3600 series programmable wall thermostat is used on this application, there will be a five minute delay when the system is powered up for the first time, and if the system switch is moved to another mode. See instructions packed with the thermostat.

1. Make sure all service disconnects are open.
2. Set thermostat switches as follows:
  - a. Fan switch to "Auto".
  - b. System switch to "Off".
  - c. Emergency heat switch to "Normal" (if separate switch).
3. Close disconnects to outdoor heat pump unit and make sure they do not trip..... nothing should run.
4. Close disconnect to furnace and make sure it does not trip..... nothing should run.
5. Turn thermostat fan switch to "On". Blower should operate.
6. Turn fan switch back to "Auto" ....nothing should run.
7. Set thermostat contacts by moving temperature setting lever above room temperature..... nothing should run.
8. Turn system switch to "Cool" .....nothing should run.
9. Set thermostat temperature setting lever below room temperature.
  - a. Outdoor unit compressor should operate.
  - b. Outdoor unit fan should operate.
  - c. Furnace blower should operate.
  - d. Cool air should flow from registers after system has operated for a few minutes.

**NOTE:** In the heating mode the indoor wall thermostat controls the system operation to maintain the selected temperature, operating either the heat pump or the furnace to do so. The selection of either is controlled by the outdoor thermostat, i.e. at temperatures above the setting, the heat pump operates in response to the first stage of the wall thermostat, at temperatures below the setting of the outdoor thermostat the furnace operates (also see the outdoor thermostat installation).

Exceptions to the above:

- A. If the heat pump fails to operate in the heating mode due to high refrigerant pressure or temperature, the furnace will operate regardless of the status of the outdoor thermostat.
- B. If the system switch of the wall thermostat is placed in "Emergency Heat" position, only the furnace will operate.
- C. If a defrost cycle is initiated by the heat pump, both the heat pump and the furnace will operate until the defrost cycle is completed.

**NOTE:** In both A and B above, the furnace operation is controlled by the second stage of the wall thermostat. During the defrost cycle the furnace is controlled by the first stage.

10. Turn system switch to heat and wait five minutes..... nothing should run.
11. Set wall thermostat setting above room temperature, just enough to close the first stage. Set the outdoor thermostat below the outdoor temperature.
  - a. Outdoor unit compressor should operate.
  - b. Outdoor unit fan should operate.
  - c. Furnace blower should operate.
  - d. Warm air should flow from registers after the system has operated for a few minutes.
12. Set wall thermostat to higher temperature.
  - a. Outdoor unit compressor should not operate.
  - b. Outdoor unit fan should not operate.
  - c. Furnace blower should operate.
  - d. Furnace should operate in response to the first stage of the wall thermostat.
  - e. Warm air should flow from the registers after a few minutes.
13. Set wall thermostat temperature lever all the way down.
  - a. Furnace should not operate.
  - b. Furnace blower should not turn off.
14. Turn wall thermostat system switch to "Emergency Heat" ..... emergency heat light should turn on, but nothing should operate.
15. Set temperature as in 11 above..... the emergency heat light should remain on, but nothing should operate.
16. Set wall thermostat temperature lever to a higher temperature so that the second stage closes.
  - a. Emergency light should be on.



- b. Auxiliary heat light should turn on.
  - c. Furnace should start operating.
  - d. Furnace blower should operate.
  - e. Warm air should flow from the registers after a few minutes.
17. Turn wall thermostat system switch to "Heat".
- a. Emergency heat light should turn off.
  - b. Auxiliary light should remain on.
  - c. Furnace should continue to operate.
  - d. Furnace blower should operate.
  - e. Outdoor unit compressor should not operate.
  - f. Outdoor unit fan should not operate.
  - g. Warm air should continue to flow from the registers.

18. Set outdoor thermostat below outdoor temperature.
- a. Furnace should stop operating.
  - b. Furnace blower should operate.
  - c. Outdoor unit compressor should operate.
  - d. Outdoor unit fan should operate.
  - e. Warm air should continue to flow from the registers.
19. Set system switch to desired mode and adjust temperature lever to desired temperature if everything checks out correctly.

**NOTE:** The heat pump has a safety lockout that will keep it from operating if some fault causes the high temperature or the high pressure limit switches to open. To reset the lockout, turn the indoor thermostat system to "Off", then back to the selected mode within 5 seconds or disconnect the power to the transformer for at least two seconds. The heat pump will now operate. Should a lockout re-occur, then the cause of the lockout should be sought and corrected immediately.